

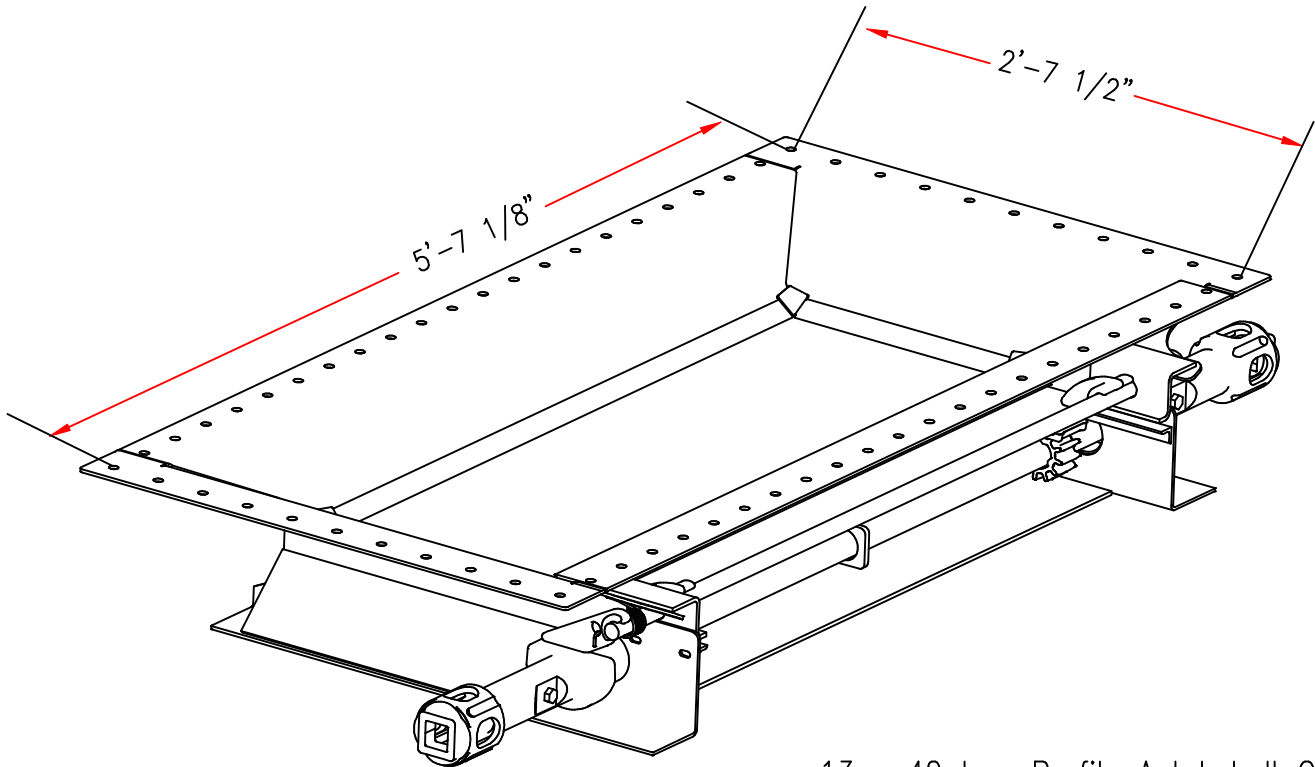

1200 EAST STATE STREET

GENEVA, IL 60134



13 x 42 Low Profile AutoLok II Gate
-W- Brush Seals

MKE10415 (64 Holes)
Arrangement Dwg. M-99-116

OPERATING HANDLE W/CAM
MKE10080

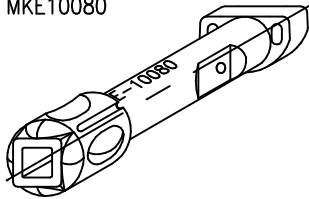

OPERATING SHAFT - 1 1/4 SQ.
MKE7551

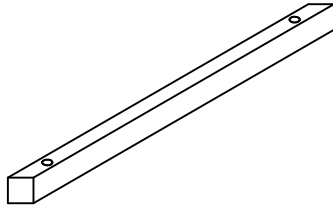

1/2-20 UNF
BOLT
P30000611

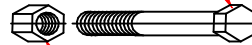

1/2-20 UNF
ELASTIC STOP NUT
P30000615

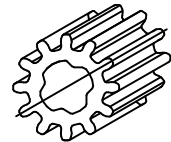

SLIP PINION
MKE10129

SIDE SEAL
MKE10316

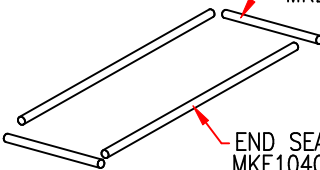

END SEAL
MKE10404

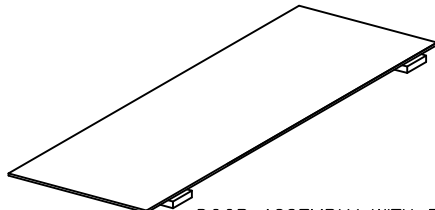

DOOR ASSEMBLY WITH RACKS
MKE10406

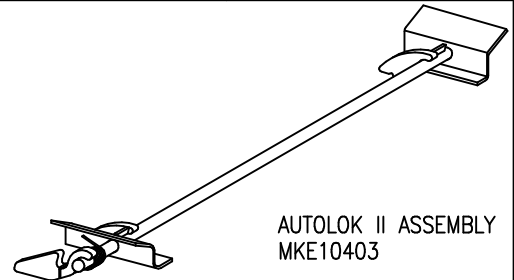

AUTOLOK II ASSEMBLY
MKE10403

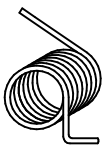

LOCK SPRING
MKE10068

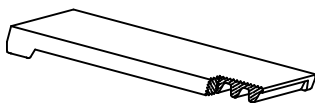

RACK WITH STOP
MKE10424



BOTTOM SEAL (SHORT) P10252004
(2) REQ'D PER OUTLET GATE
INSTALL USING:
P30000207 1/4-20 X 7/8 HHCS (4/GATE)
P30000209 1/4 WASHER (8/GATE)
P30000203 1/4-20 LOCKNUT (4/GATE)

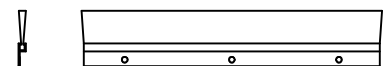

BOTTOM SEAL P10415001
(2) REQ'D PER OUTLET GATE
INSTALL USING:
P30000207 1/4-20 X 7/8 HHCS (6/GATE)
P30000209 1/4 WASHER (12/GATE)
P30000203 1/4-20 LOCKNUT (6/GATE)